

# Data Sheet



Article number: 201017093

Description: E+G Clamping jaw blank GN 872-30-25

## Measures

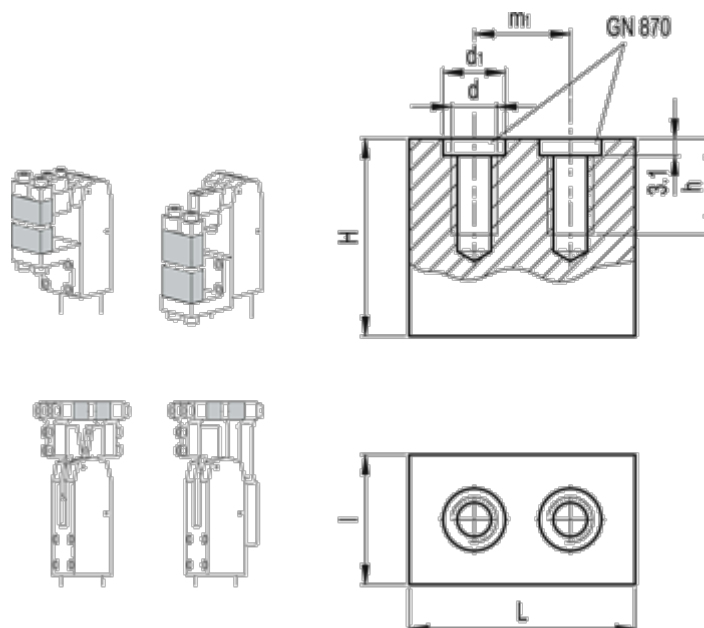

d	= M6
d1 H8/h6	= 9
h	= 13
H	= 25
l	= 13
L	= 30
m1	= 17
Weight (g)	= 136